

Stationary concrete pump

BSA 2109 H D

BSA 2109 H E

Output up to 95 m³/h

Delivery pressure up to 152 bar

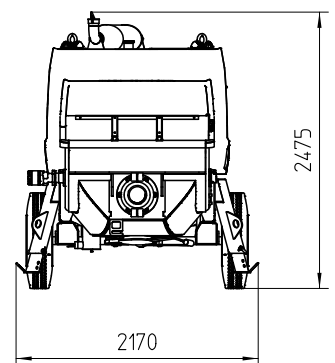
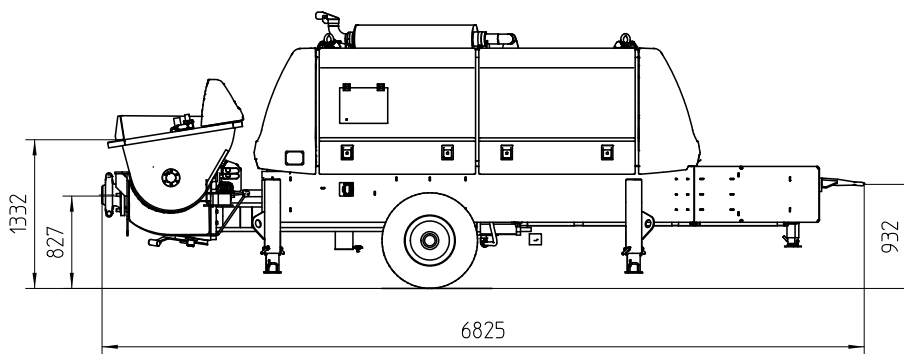

Note: Standard version BSA 2109 H D. Dimensions and weights depend on equipment. Subject to technical modifications and errors.

Technical data

Model		BSA 2109 H D	BSA 2109 H E
Material number		102437.000	102436.000
Output	m ³ /h	95 / 57 *	85 / 51 *
Delivery pressure	bar	91 / 152 *	
Delivery cylinder	Ø mm	200	
Delivery cyl. stroke	mm	2100	
Strokes / minute		24 / 15 *	21 / 13 *
Engine / motor power	kW	200	160
Hopper		RS 905 H	
Capacity	l	approx. 600	
Filling height	m	approx. 1.3	
Transfer tube		S 2015 D	
Line connection	mm	ZX 150	
Pressure connection	"	8	
Control system		EPS FFH	
Weight	kg	6300	6600

* Values for hydraulic fluid being fed to piston-side
All data maximum theoretical

Serial equipment

Agitator safety switch off	Electronic error management
Cable remote control 10 m	Ergonic Graphic Display (EGD)
Central lubrication on hopper with hand lever press	Flushing water pump 50 l/min 20 bar
Cleaning accessories	Gate valve connection
Coloring: Pump, frame, roof, tank and hood anthracite-grey Cover chrome yellow	Grill 60 mm
Concrete hopper with agitator	Hard metal wear parts
Concrete output adjust	Operating manuals (1× paper, 1× CD-ROM) spare part list
Concrete pressure adjust	Outriggers 4× mech.
Coupling ring (DIN)	Pump flow meter
Drive diesel, Deutz 200 kW (BSA 2109 H D)	Set-up foot mech.
Drive electric 160 kW (BSA 2109 H E)	Speed drawdown automatically on pump stop (BSA 2109 H D)
	Splash guard
	Tool set incl. standard equipment
	Trailer F8, travelling in site

See quotation for exact serial delivery scope.
Comprehensive range of options available on request.